

CS120

Dead Load (kN/m ²)	
1.57 (75mm Lightweight Screed) + 0.04 (75mm Insulation)	2.40 (100mm Conc)

Partition Allowance (kN/m ²)		Garage 9kN (point)
0.50	1.00	

Imposed Load

Configuration	1.50	2.00	3.00	4.00	5.00	7.50	2.50
---------------	------	------	------	------	------	------	------

S516	4.265	3.910	3.615	3.215	2.840	2.190	3.475
S404	4.780	4.390	4.065	3.795	3.570	2.800	3.780
S291	5.300	5.100	4.740	4.430	4.175	3.690	4.125

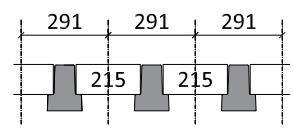
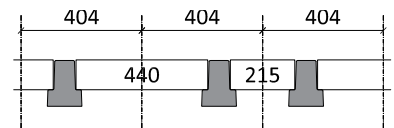
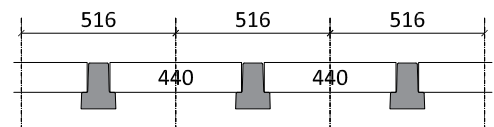
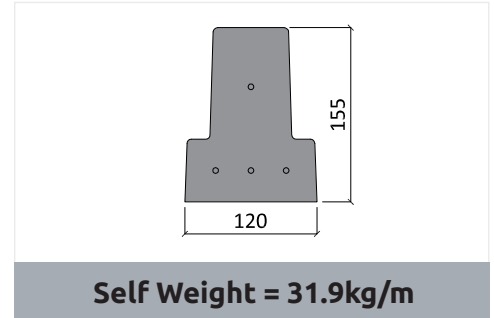

CS160

Dead Load (kN/m ²)	
1.57 (75mm Lightweight Screed) + 0.04 (75mm Insulation)	2.40 (100mm Conc)

Partition Allowance (kN/m ²)		Garage 9kN (point)
0.50	1.00	

Imposed Load

Configuration	1.50	2.00	3.00	4.00	5.00	7.50	2.50
---------------	------	------	------	------	------	------	------

S556	5.160	4.745	4.410	4.140	3.910	3.465	4.630
S444	5.710	5.260	4.900	4.605	4.355	3.870	4.985
S331	6.300	5.985	5.590	5.265	4.990	4.450	5.450

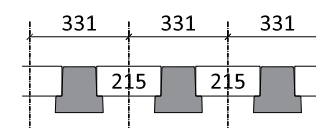
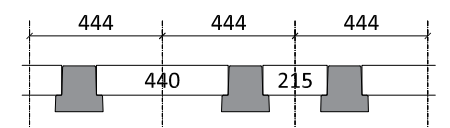
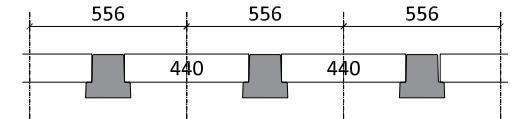
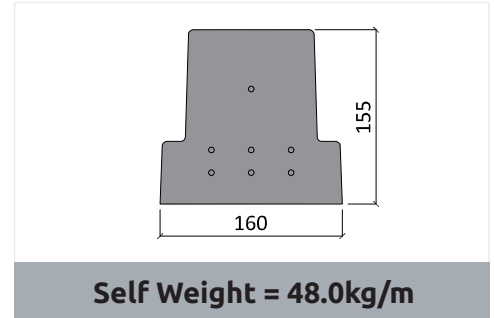

CS225

Dead Load (kN/m ²)	
1.57 (75mm Lightweight Screed) + 0.04 (75mm Insulation)	2.40 (100mm Conc)

Partition Allowance (kN/m ²)		Garage 9kN (point)
0.50	1.00	

Imposed Load

Configuration	1.50	2.00	3.00	4.00	5.00	7.50	2.50
---------------	------	------	------	------	------	------	------

S528	6.585	6.080	5.675	5.340	4.855	3.465	5.955
S416	7.275	6.740	6.310	5.950	5.640	3.870	6.610
S303	8.000	7.670	7.205	6.815	6.480	5.820	7.310

